



INSTALLATION INSTRUCTIONS

Accessory SECOND ROW SEAT COVERS P/N 08P32-TK8-100	Application 2015 ODYSSEY	Publications No. VERSION 1
		Issue Date JULY 2014

Put this information in the glove box with the vehicle owner's manual.

PARTS LIST

2 Second row headrest covers



Second row left seat cover

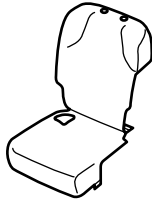

2 Second row seat armrest covers



Second row right seat cover

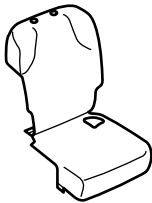

Second row center headrest cover
(Not used on LX model)



Second row center seat back cover
(Not used on LX model)



Second row center seat cushion cover
(Not used on LX model)

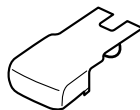
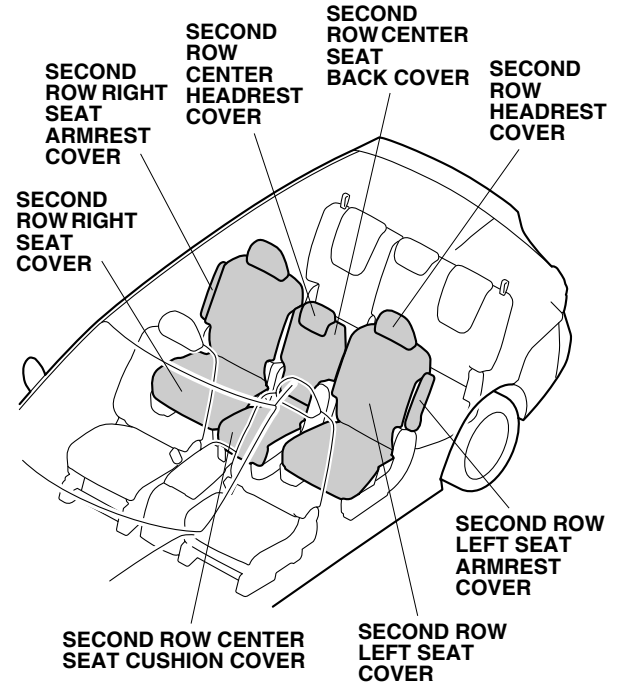

Illustration of the Second Row Seat Covers Installed on the Vehicle



INSTALLATION

Customer Information: The information in this installation instruction is intended for use only by skilled technicians who have the proper tools, equipment, and training to correctly and safely add equipment to your vehicle. These procedures should not be attempted by "do-it-yourselfers."

NOTE:

- Be careful not to damage the seats while installing the seat covers.
- Do not install the second row seat covers on the front seats. Improperly covering the front seats can prevent your side airbags from inflating in a side impact.
- Identify each second row seat cover by the tags on the back.

1. Push the knobs and remove each headrest from the second row seats.

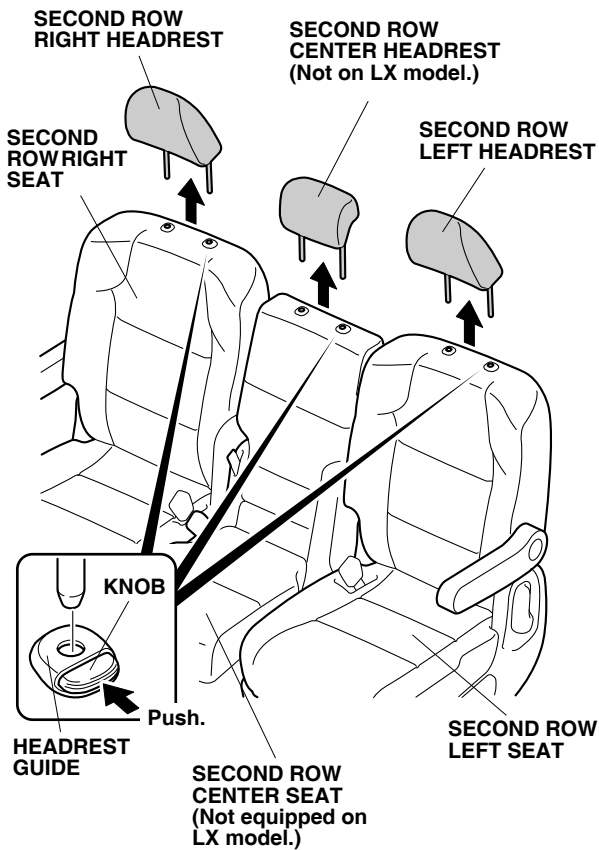

2. Install a second row headrest cover to each headrest.

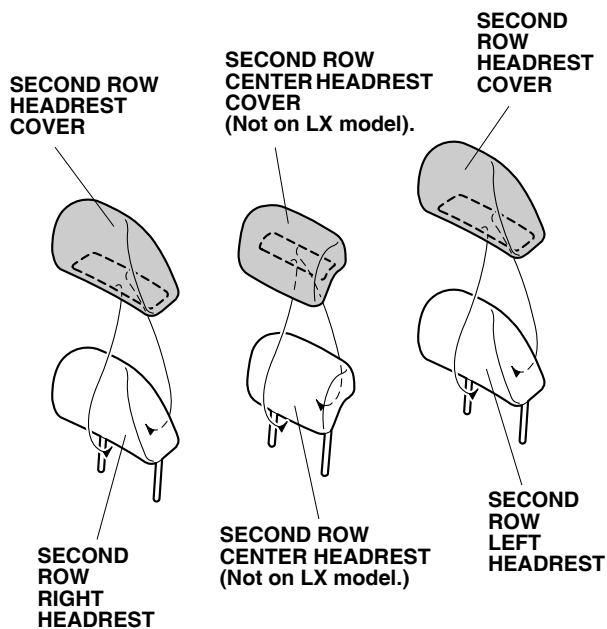

3. Install the second row left seat cover to the second row left seat in the order 1 → 2 → 3 → 4.
NOTE: Make sure that the headrest guide on the second row left seat is not covered by the second row left seat cover.

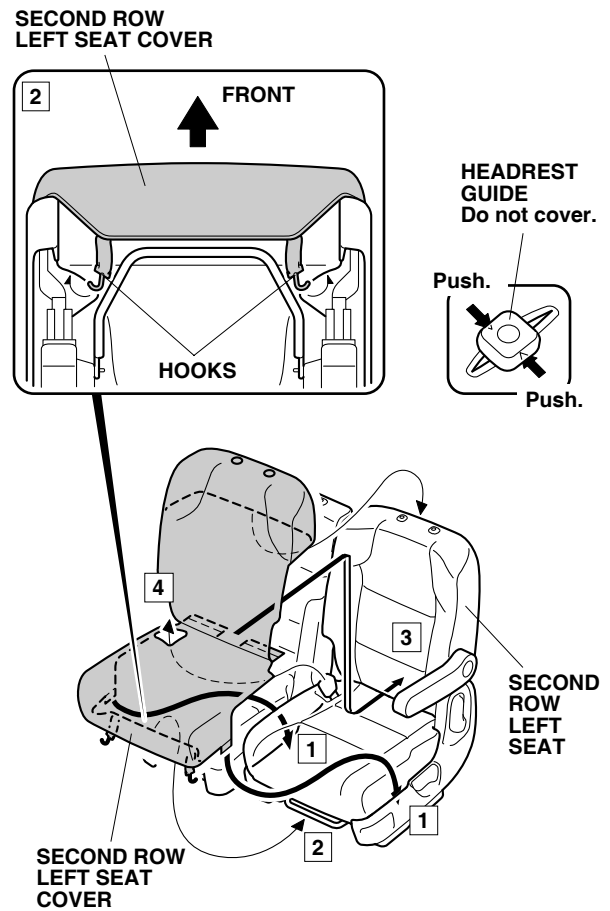

- Fold the second row left seat forward halfway.

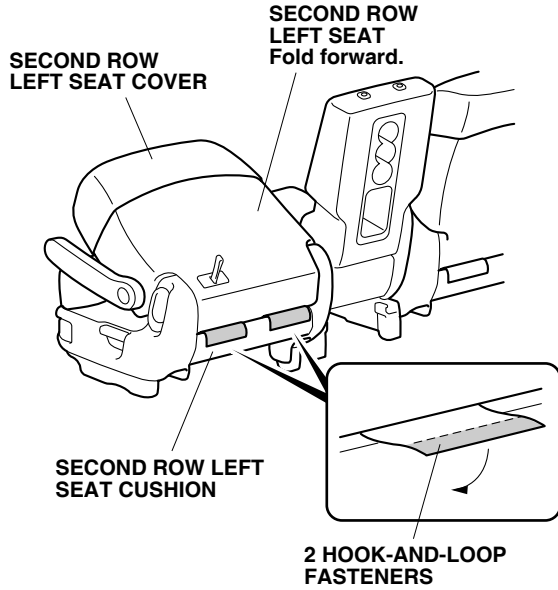

- Secure the second row left seat cover to the second row left seat cushion with the two hook-and-loop fasteners.
- Return the second row left seat to its standard position.

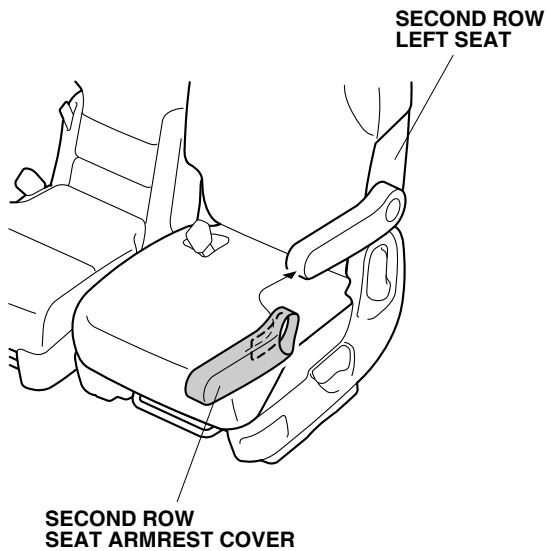

- Install a second row seat armrest cover to the second row left seat armrest. On the LX model, install this cover to the inboard armrest.
- Repeat steps 3 thru 7 to install the second row seat cover on the second row right seat.

If the vehicle you are working on is an LX model, go to step 15. If not, continue with step 9.

- Install the second row center seat back cover to the second row center seat back in the order 1 → 2. NOTE: Make sure that headrest guide on the second row center seat back is not covered by the second row center seat back cover.

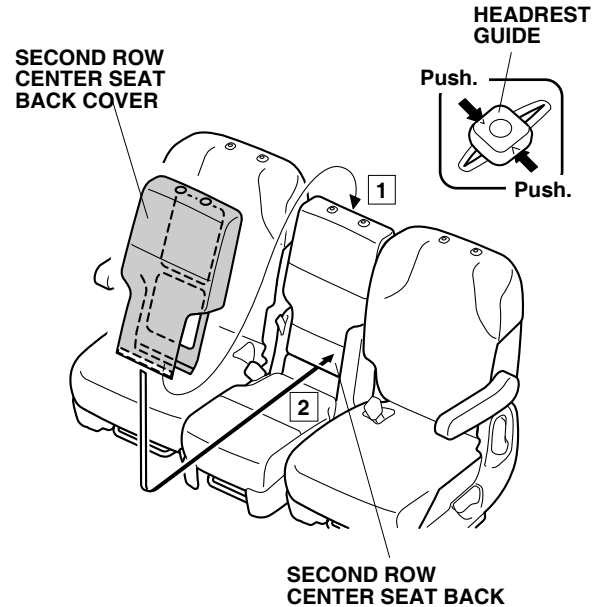

- Fold the second row center seat forward.

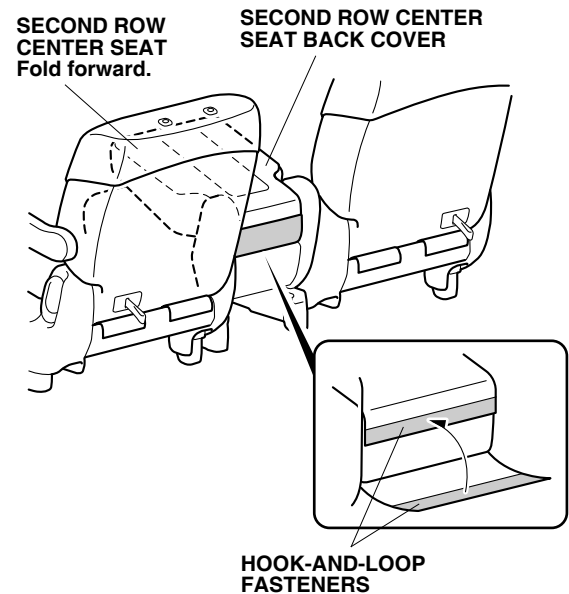

- Secure two hook-and-loop fasteners on the second row center seat back cover as shown.

12. Return the second row center seat to the up position.

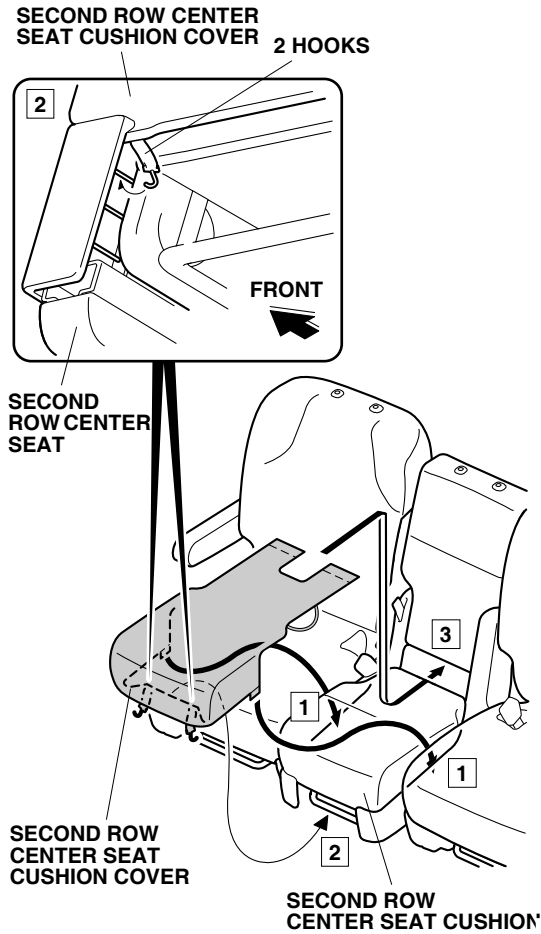

13. Install the second row center seat cushion cover to the second row center seat in the order

1 → **2** → **3**.

14. Secure the second row center seat cushion cover to the second row center seat with the two hook-and-loop fasteners.

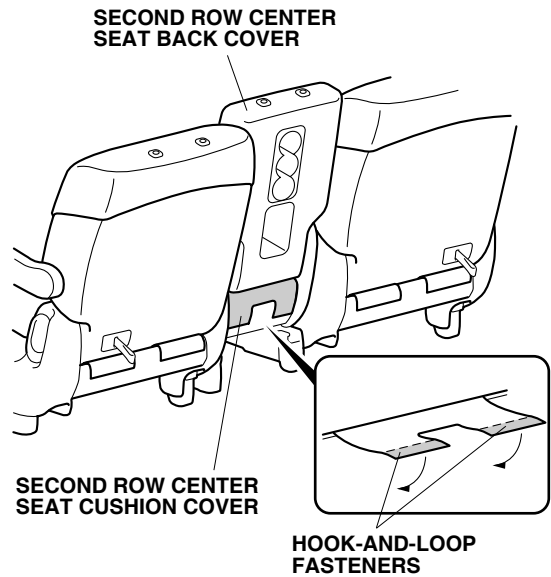

15. Reinstall the headrests.