



INSTALLATION INSTRUCTIONS

Accessory
HOOD AIR DEFLECTOR
P/N 08P47-SZA-100

Application
2014 PILOT

Publications No.
All 50256
Issue Date
AUG 2013

PARTS LIST

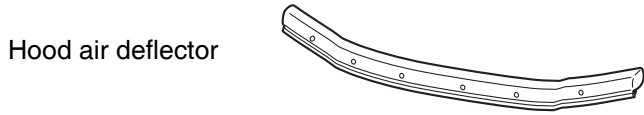

4 Protective tapes 

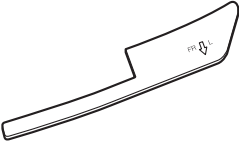
Template 

3 Rubber blocks 

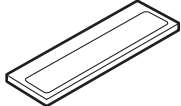
Hood label 

TOOLS AND SUPPLIES

Phillips screwdriver

Felt-tip pen

Masking tape

Illustration of the Hood Air Deflector on the Vehicle

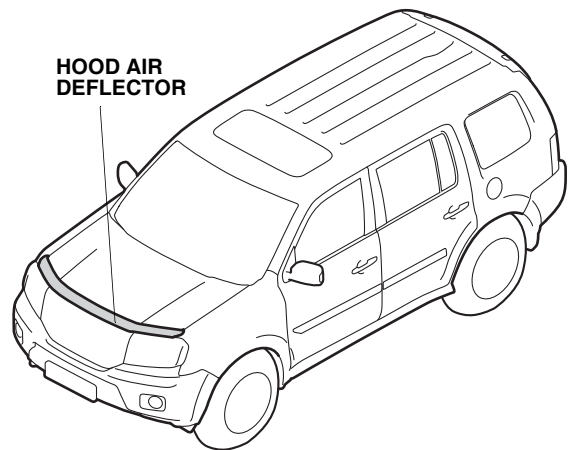

INSTALLATION

Customer Information: The information in this installation instruction is intended for use only by skilled technicians who have the proper tools, equipment, and training to correctly and safely add equipment to your vehicle. These procedures should not be attempted by “do-it-yourselfers.”

NOTE:

- Do not damage the body finish when you install the hood air deflector.
- This hood air deflector kit should be installed only when the ambient air temperature is above 15°C (60°F).
- To allow the adhesive to cure, do not wash the vehicle for 24 hours. Please advise the customer.

Installing the Hood Air Deflector

1. Open the hood. Locate the four square holes in the hood. Push a grommet nut into each square hole.

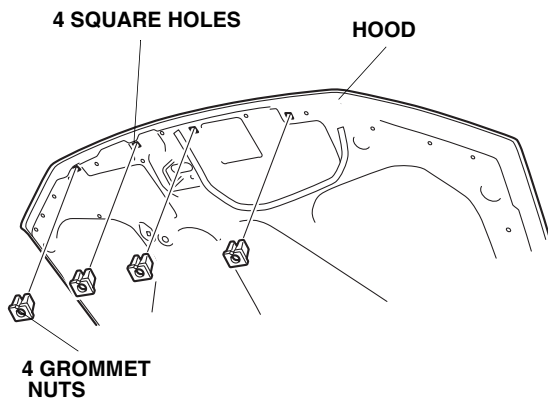

2. Using an alcohol pad, thoroughly clean the hood where the protective tapes will attach.

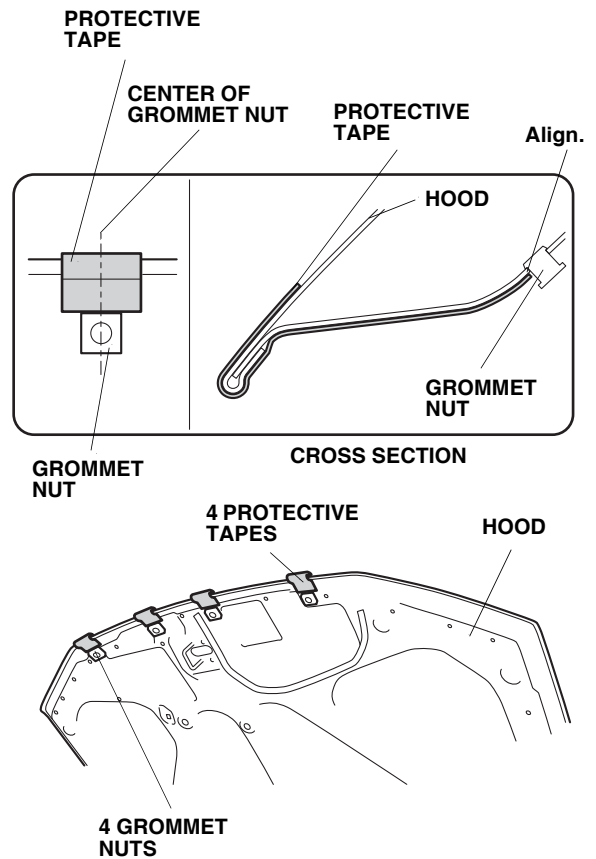

3. Remove the adhesive backings from each protective tape and attach the four protective tapes around the front of the hood as shown.

- Position two brackets A and two brackets B over the protective tapes, and loosely install them with four truss screws.

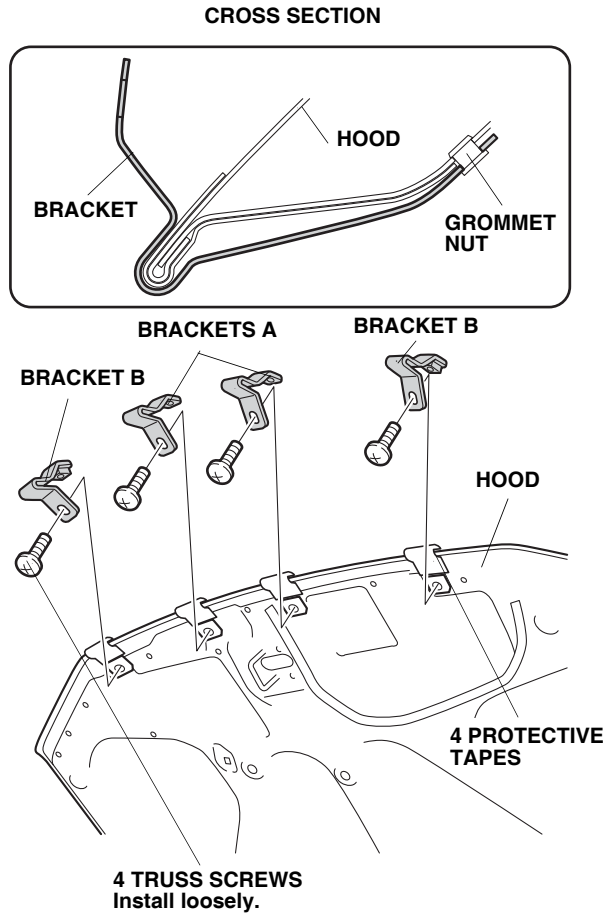

- Using an alcohol pad, thoroughly clean the hood where the rubber blocks and the hood label will attach.

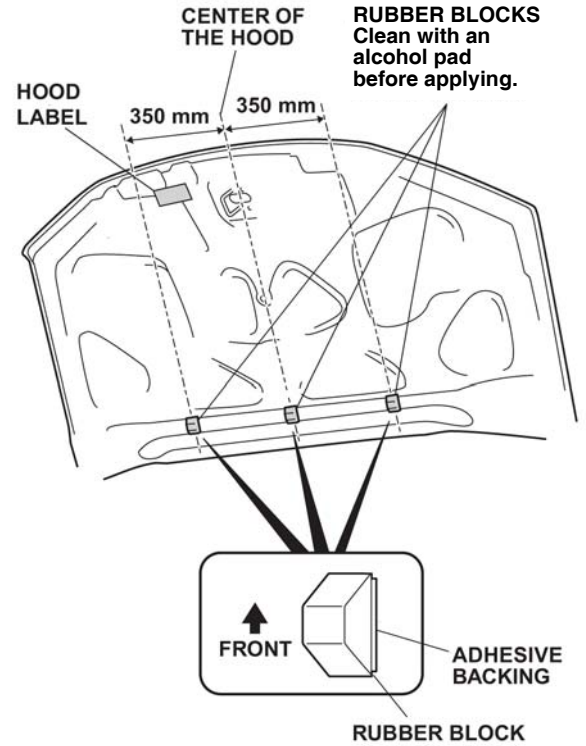

- Remove the adhesive backings from the three rubber blocks and the hood label, and attach them to the hood at the measurements shown.

7. Close the hood. Using an alcohol pad, thoroughly clean the hood where the bracket C will attach.

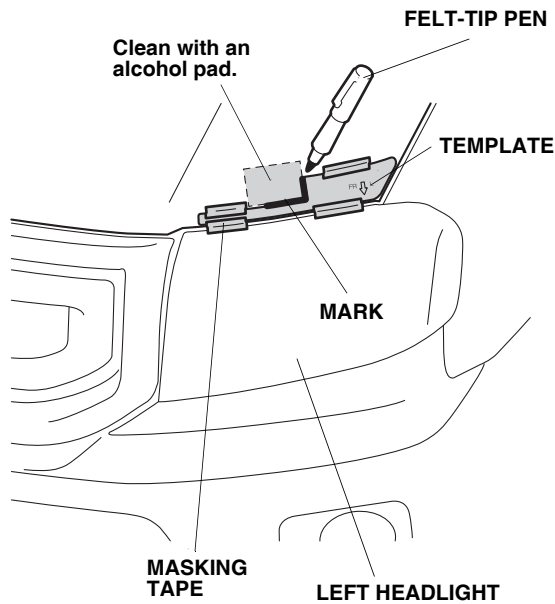

8. Align the template to the hood and attach it with masking tape. Using a felt-tip pen, mark on the hood as shown.
9. Remove the template.
10. Remove the adhesive backing from bracket C and attach it to the mark made in step 8. Make sure that bracket C is installed in the correct direction.

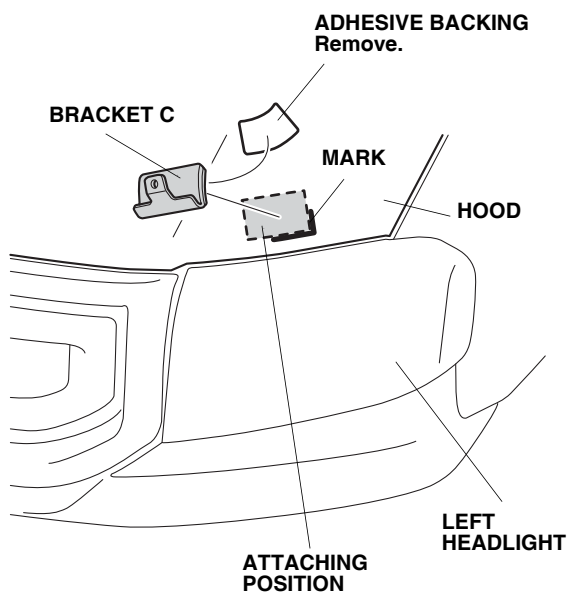

11. Turn the template over and repeat steps 7 through 10 to install the other bracket C on the right side of the hood.

12. Peel back 1½ inches of adhesive backing from each adhesive tape, and tape the ends to the front surface of the hood air deflector.

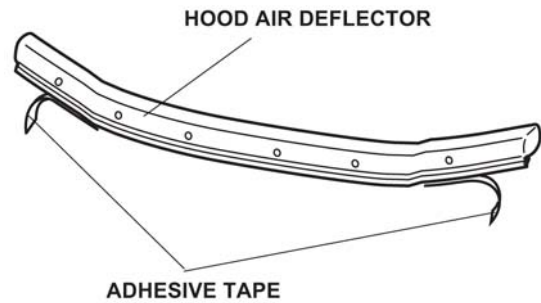

13. Align the holes on the hood air deflector with the brackets A, B, C. Install the hood air deflector with two screws, two collars, and four clips. Tighten the screws securely. Remove the adhesive backings.

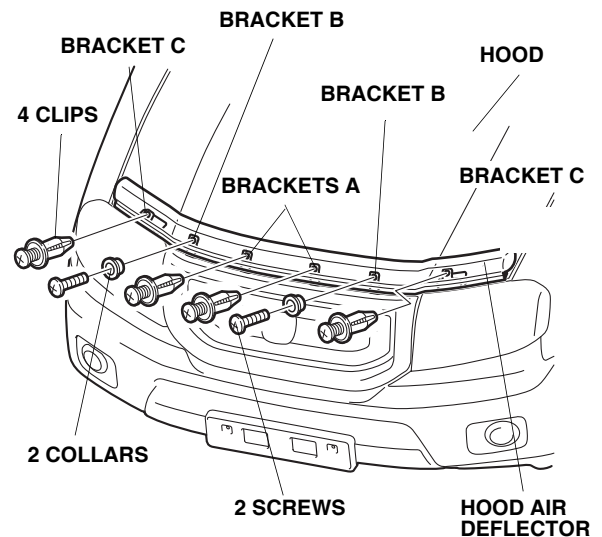

14. Insert the large end of the template between the hood and the hood air deflector to unfold the molding as necessary.

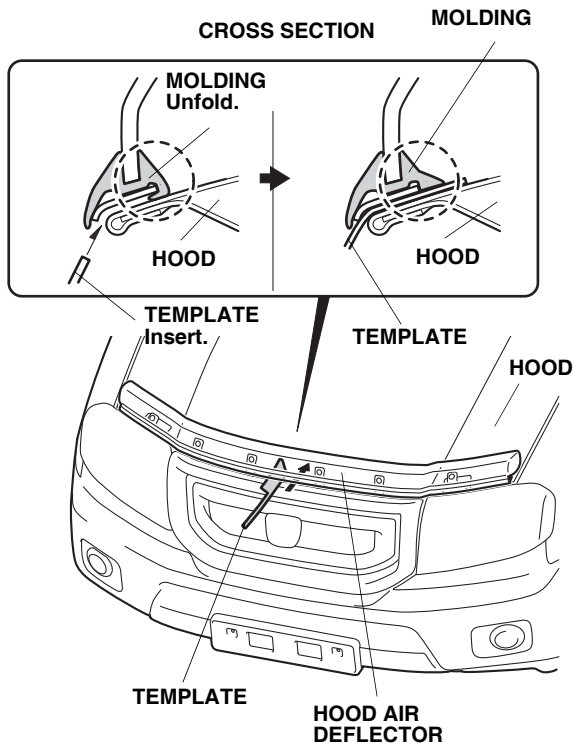

15. Open the hood. Tighten the four truss screws loosely installed in step 4.