

PARTS LIST

Left front door edge film

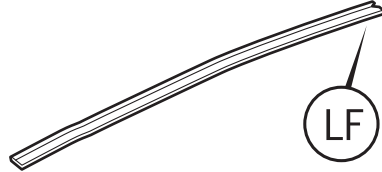

Right front door edge film

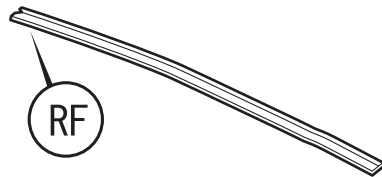

Left rear door edge film

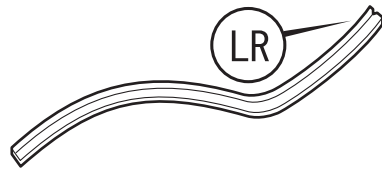

Right rear door edge film

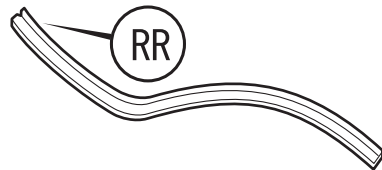

Applicator

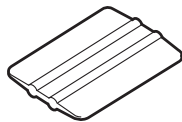

Soft sleeve

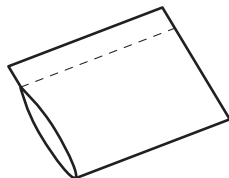

2 Alcohol swabs

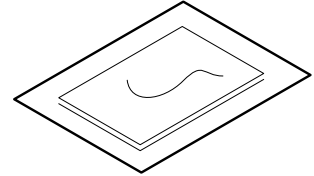
**TOOLS AND SUPPLIES REQUIRED**

Shop towel

Lint-free shop towel

Spray bottle

3M Protective tape application solution

INSTALLATION**NOTE:**

- These instructions show the left door edge film being installed. The same procedure applies to installing the right door edge film.
- Identify each door edge film by referring to the identification marks.
- Be careful not to damage the body paint finish.
- The door edge film should be installed only if the ambient air temperature is 15°C (60°F) or above.
- To allow the adhesive to cure, do not wash the vehicle for 24 hours.

Installing the Front Door Edge Film

1. Open the left front door. Using an alcohol swab, thoroughly clean the area where the left front door edge film will attach.

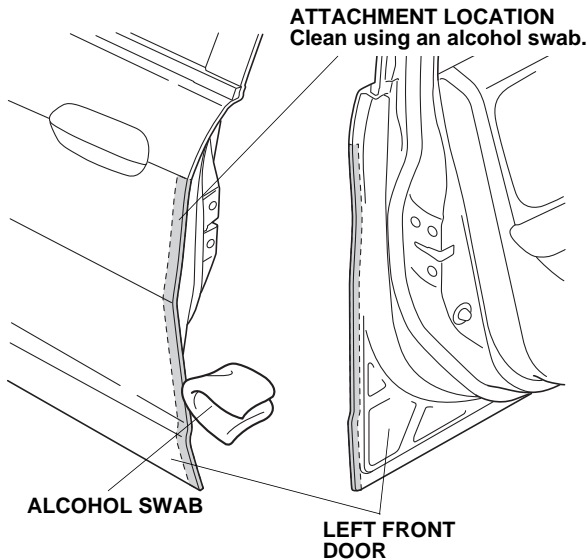

2. Close the left front door. Using a spray bottle with 3M protective tape application solution, spray the area where the left front door edge film will attach.
NOTE: Do not spray the inside surface of the door.

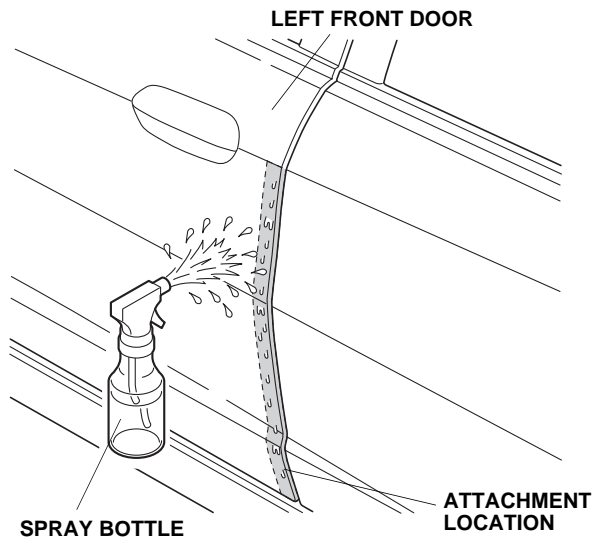

3. Open the left front door again. Peel back about 50 mm (2 in.) of adhesive backing from the left front door edge film. Align the V-notch in the door edge film with the end of the character line on the upper part of the front door.

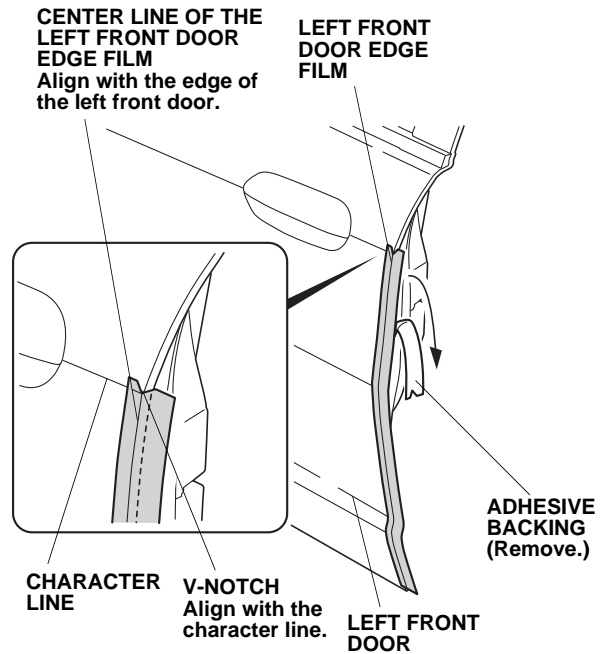

4. Continue to remove the adhesive backing while you align the center line on the door edge film with the edge of the door.
5. Insert the applicator into the soft sleeve. Starting in the middle of the door edge film and working outward, use the applicator to smooth out any bubbles in the film. To avoid lifting the film, move the applicator in only one direction.

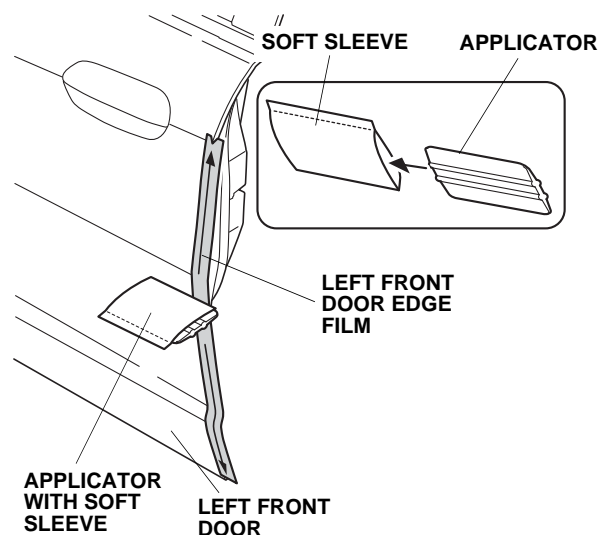

- When you are satisfied that the door film is firmly attached to the edge of the door, slowly remove the outer protective film.

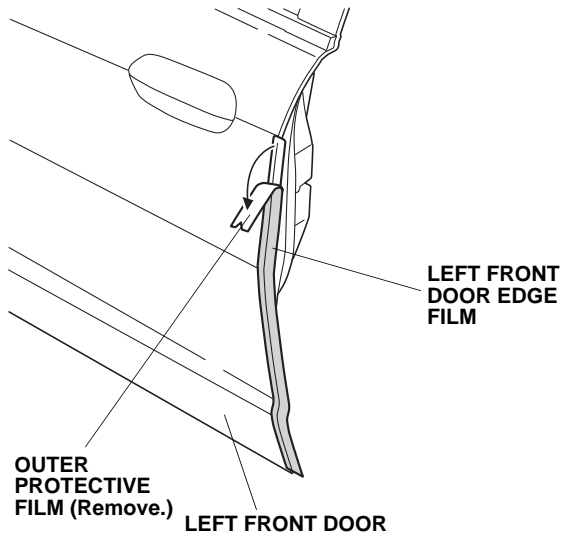

- Starting in the middle of the door edge film and working outward, fold the left front door edge film around the door edge using your fingers. Move your fingers in one direction. Attach the film over the seam sealant. Do not trim or damage the seam sealant.

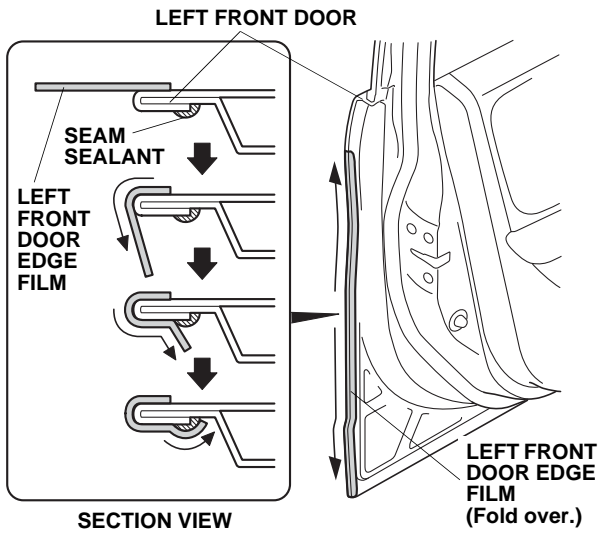

- Using a lint-free shop towel, wipe up the liquid from the front door edge film. Allow the front door edge film to dry thoroughly.

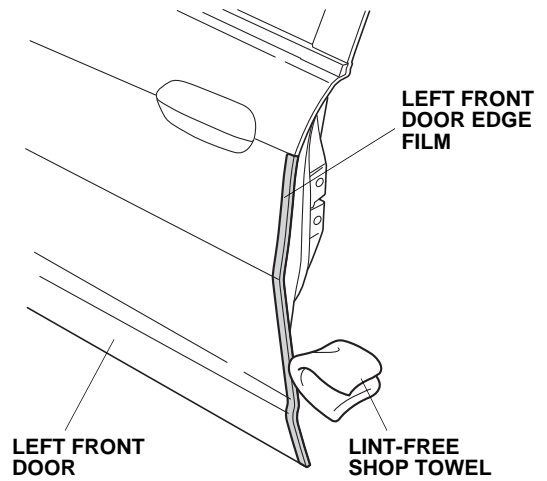

- Repeat steps 1 through 8 to install the door edge film on the right front door.

Installing the Rear Door Edge Film

- Open the left rear door. Using an alcohol swab, thoroughly clean the area where the left rear door edge film will attach.

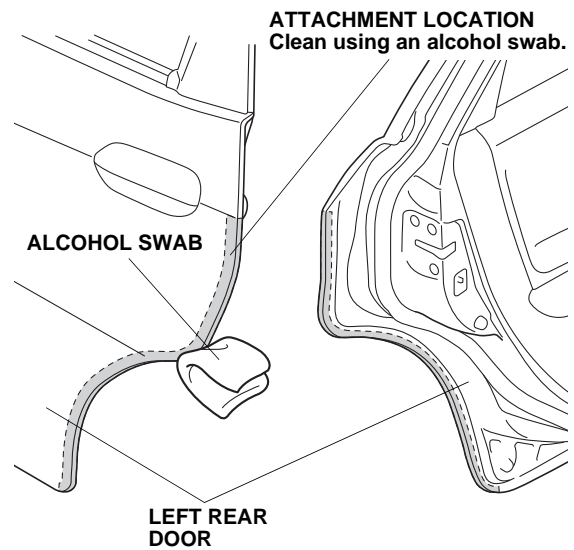

- Close the left rear door. Using a spray bottle with 3M protective tape application solution, spray the area where the left rear door edge film will attach.
NOTE: Do not spray the inside surface of the door.

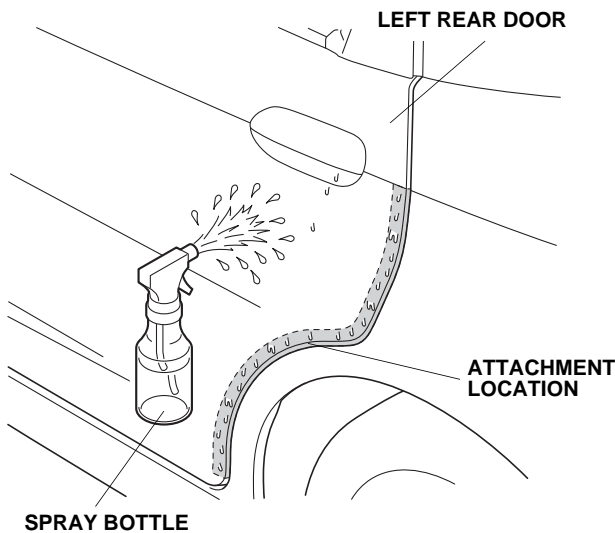

- Open the left rear door again. Peel back about 50 mm (2 in.) of adhesive backing from the left rear door edge film. Align the V-notch in the door edge film with the end of the character line on the upper part of the left rear door.

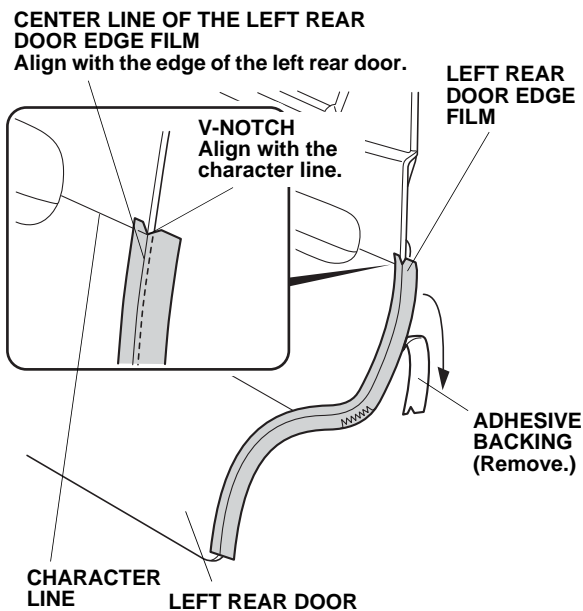

- Continue to remove the adhesive backing while you align the center line on the door edge film with the edge of the door.

- Insert the applicator into the soft sleeve. Starting in the middle of the door edge film and working outward, use the applicator to smooth out any bubbles in the film. To avoid lifting the film, move the applicator in only one direction.

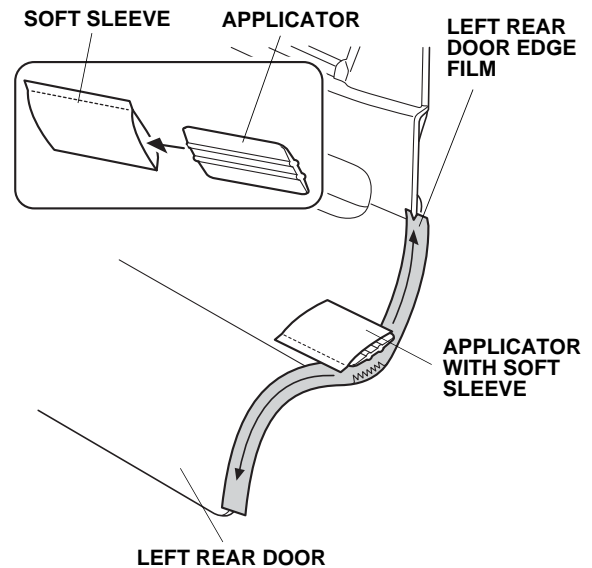

- When you satisfied that the door edge film is firmly attached to the edge of the door, slowly remove the outer protective film.

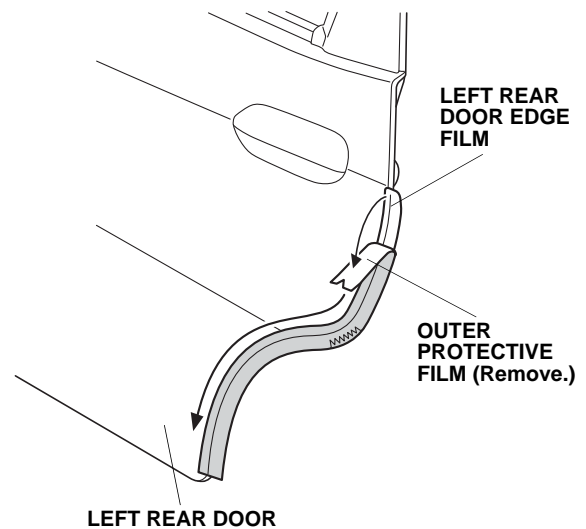

16. Starting in the middle of the door edge film and working outward, fold the film around the door edge using your fingers. Move your fingers in one direction. Attach the film over the seam sealant. Do not trim or damage the seam sealant.

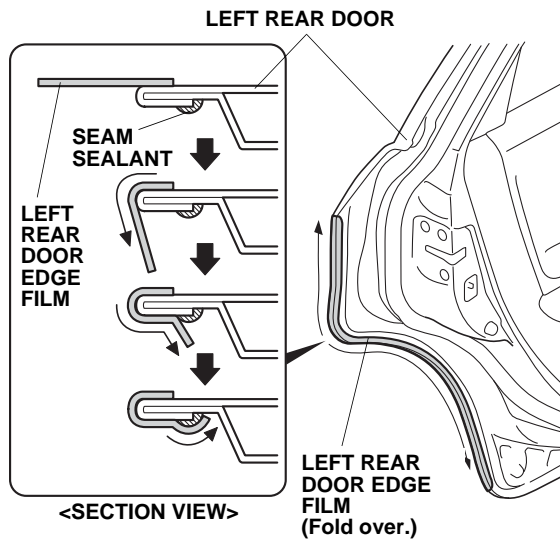

17. Using a lint-free shop towel, wipe up the liquid from the rear door edge film. Allow the rear door edge film to dry thoroughly.

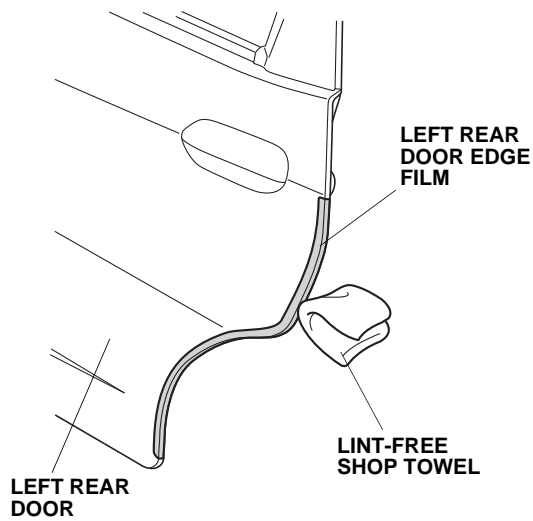

18. Repeat steps 10 through 17 to install the door edge film on the right rear door.