



INSTALLATION INSTRUCTIONS

Accessory

**RUNNING BOARD
P/N 08L33-SJC-100**

Application

2007 RIDGELINE

Publications No.

All 32423

Issue Date

MAY 2006

PARTS LIST

Left running board

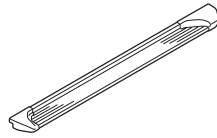

Right running board

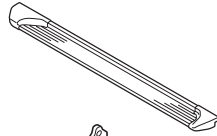

2 Brackets A



6 Brackets B

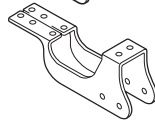

8 Brackets C

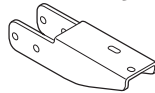

62 Flange bolts



48 Flange nuts



2 Knurled threaded inserts



TOOLS AND SUPPLIES REQUIRED

Ratchet

Clip remover

13 mm Socket

13 mm Combination wrench

Extension

Blanket

Torque wrench

Insert tool

Rivet nut installation tool (8 mm)

T/N: LEM722M8

27 mm Wrench

INSTALLATION

Customer Information: The information in this installation instruction is intended for use only by skilled technicians who have the proper tools, equipment, and training to correctly and safely add equipment to your vehicle. These procedures should not be attempted by "do-it-yourselfers."

NOTE:

- Thoroughly clean the bottom of the body from the rear of the front wheels to the front of the rear wheels.
- Be careful not to damage the body paint finish. To prevent damage, place a blanket under the running board during the installation.
- These instructions show the left side running board being installed; the same procedure applies to installing the right side running board.

1. Assemble six front bracket assemblies using brackets B and C along with four flange bolts and four flange nuts. Leave the nuts and bolts loose at this time.

Front Bracket Assembly:

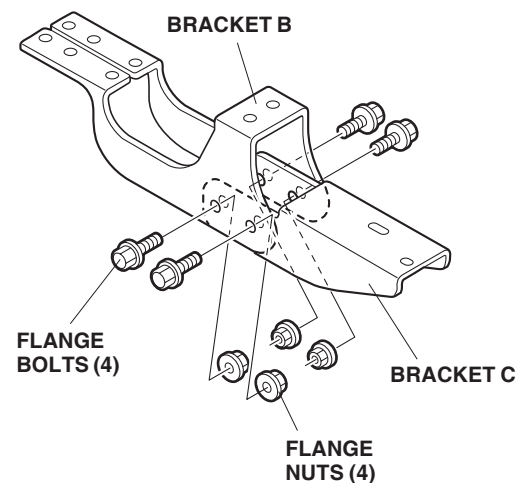

- Assemble two rear bracket assemblies using brackets A and C along with four flange bolts and four flange nuts. Leave the nuts and bolts loose at this time.

Rear Bracket Assembly:

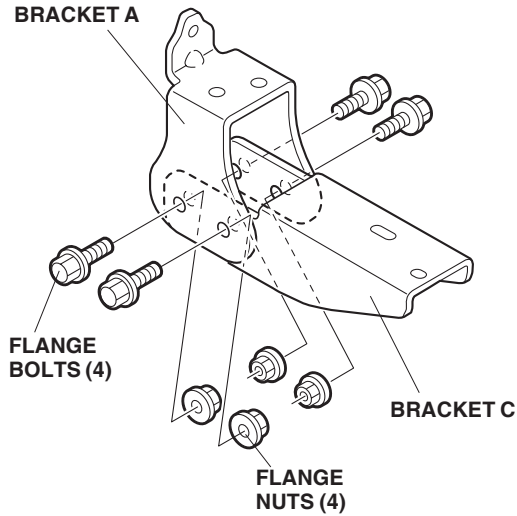

- Under the vehicle, locate and remove the grommet from the body, and install the knurled threaded insert into the grommet hole as described in the following steps.

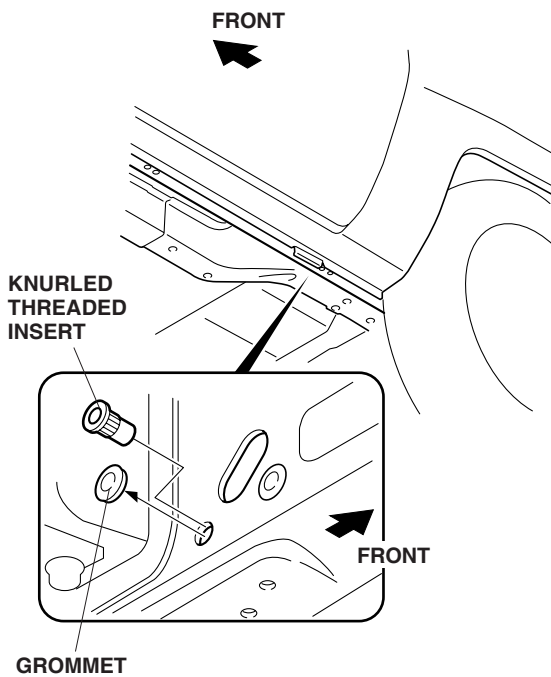

Installing the Knurled Threaded Insert

- Screw the knurled threaded insert onto the mandrel of the tool as shown.

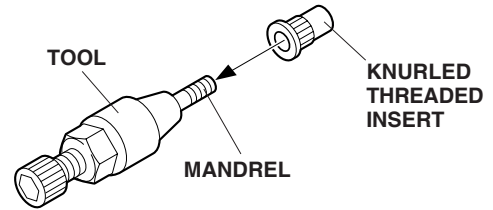

- Push the knurled threaded insert into the hole in the vehicle panel and install the hex wrench onto the tool.

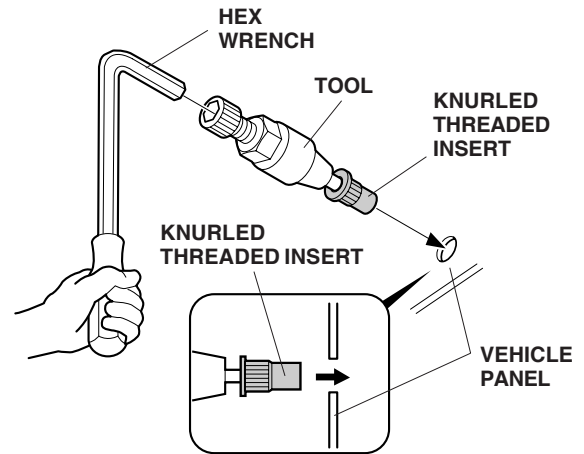

- Holding the tool with the hex wrench, turn the 27 mm wrench clockwise and install the knurled threaded insert onto the vehicle panel.

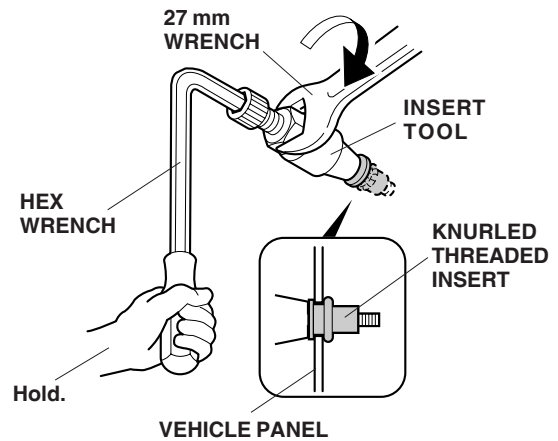

- Remove the tool from the knurled threaded insert by turning the hex wrench counterclockwise.

- Remove and discard the eight clips from the bottom of the body.

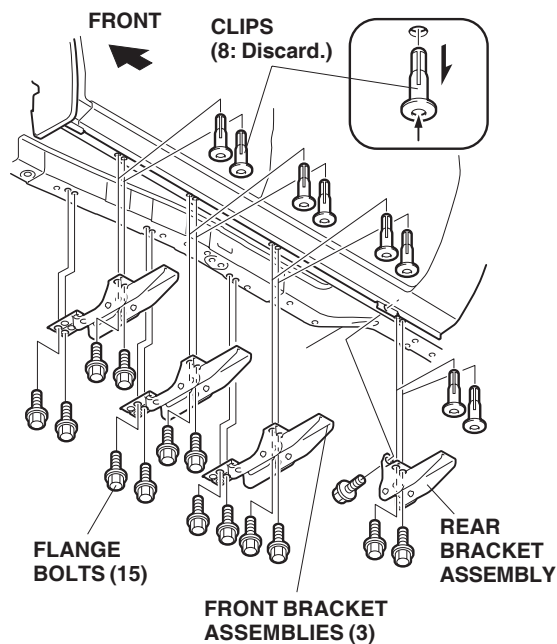

- On the left side of the vehicle, install three front bracket assemblies at the front, and one rear bracket assembly at the rear along the body using 15 flange bolts. Thread the flange bolts in about 3 to 4 threads.
- Set the running board on the brackets with the bolts through the holes in the brackets. Install the eight flange nuts onto the ends of the bolts, but don't tighten the flange nuts yet.

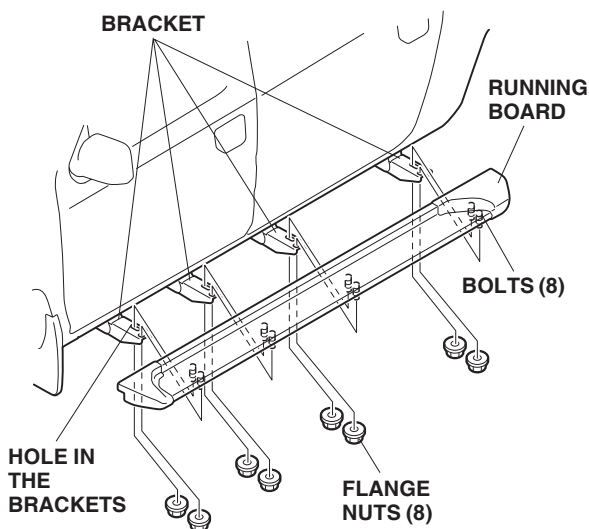

- Align the rear of the running board with the end of the inner fender, then tighten the flange bolts you installed in step 9. Torque 14 flange bolts to 27 N·m (20 lbf·ft) and the one remaining flange bolt to 7 N·m (5 lbf·ft).

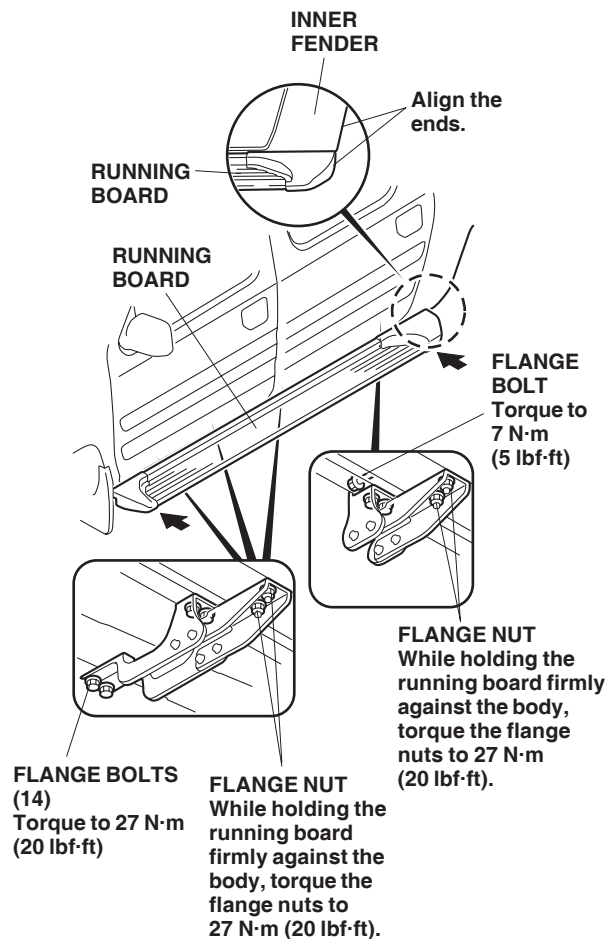

- Torque the flange bolts you installed in steps 1 and 2 to 27 N·m (20 lbf·ft).
- While holding the running board firmly against the body, torque the flange nuts to 27 N·m (20 lbf·ft).
- Repeat steps 3 through 13 to install the running board on the right side of the vehicle.