



INSTALLATION INSTRUCTIONS

Accessory

CARGO NET (LX)
P/N 08L96-S9V-100

Application

2006 PILOT

Publications No.
All 30485

Issue Date
SEP 2005

Keep this information in the glove box for future reference.

PARTS LIST

Cargo net

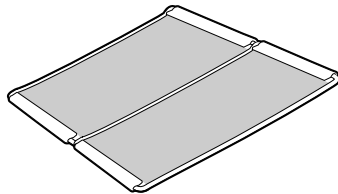

4 Hooks

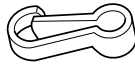

TOOL REQUIRED

Small flat-tip screwdriver

INSTALLATION

NOTE:

- Some luggage stored in the cargo net may interfere with the tailgate when it is closed. To prevent damage to the cargo, do not store large or fragile articles in the cargo net.
- Before storing articles that have sharp edges or corners, wrap them with paper or in a blanket so their sharp edges or corners will not contact the cargo net directly.

1. Using a small flat-tip screwdriver or the ignition key, release the seat belt lower hook from each third row seat. Attach the seat belt clips to the seat belts.

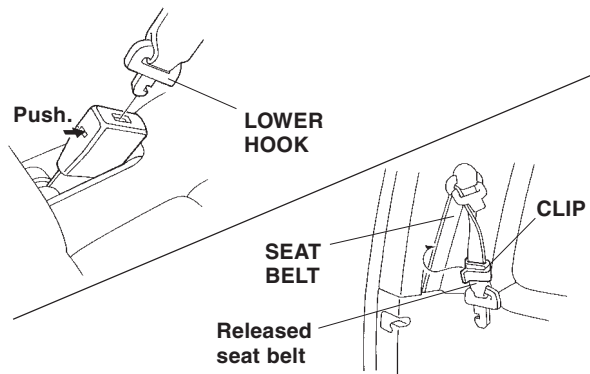

2. Remove the headrests from the third row seats; push the release buttons and pull the headrests out.

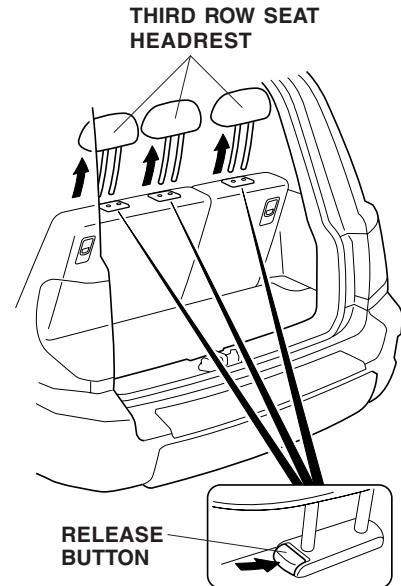

3. Store the headrests in the storage compartment under the cargo floor. Insert the posts of the headrests into the holes in the front of the storage compartment.

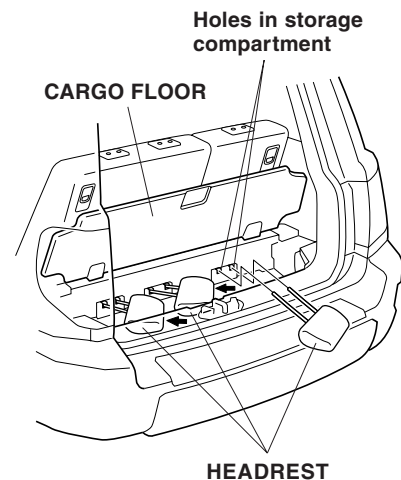

4. Fold down both third row seats.

Installing the Cargo Net in the Horizontal Position

5. Attach the four hooks onto the cargo net in the areas shown.

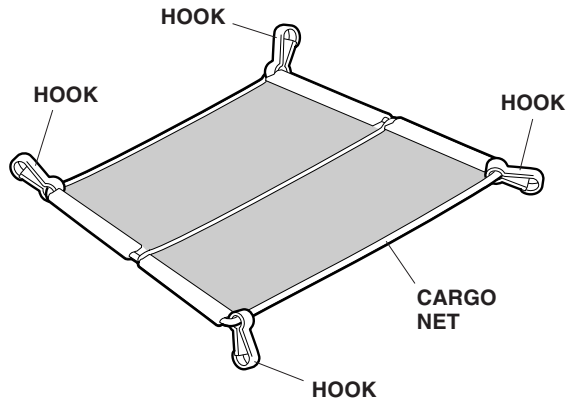

6. Attach the hooks of the cargo net to the front, and to the rear anchors.

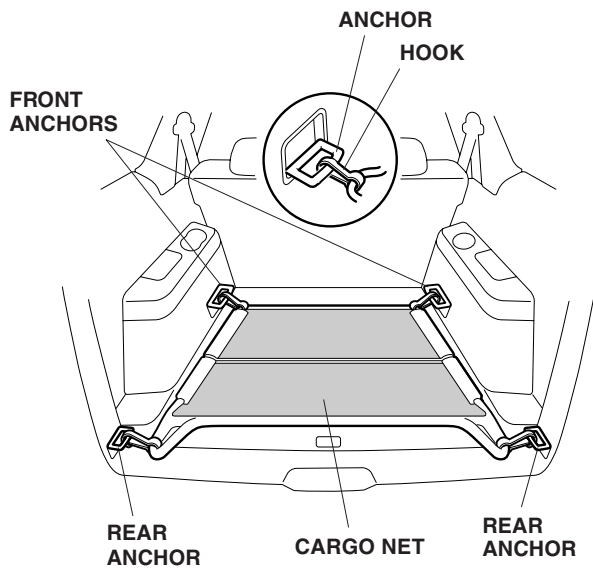

Installing the Cargo Net in the Vertical Position

7. Attach two hooks to the cargo net in the areas shown.

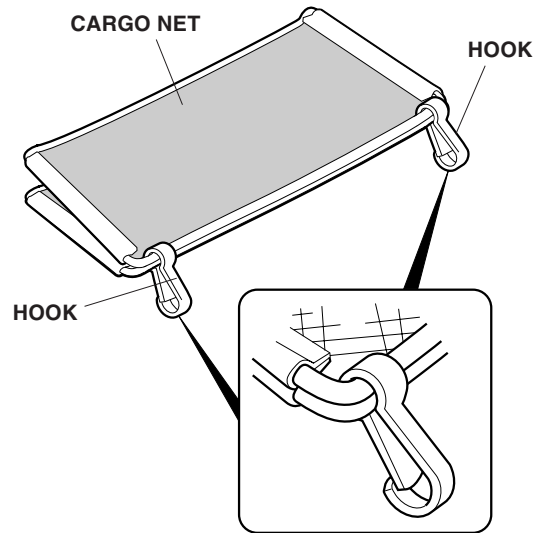

8. Attach the hooks to the anchors in the floor, and attach the loops to the tie-down hooks on the rear side trim panel.

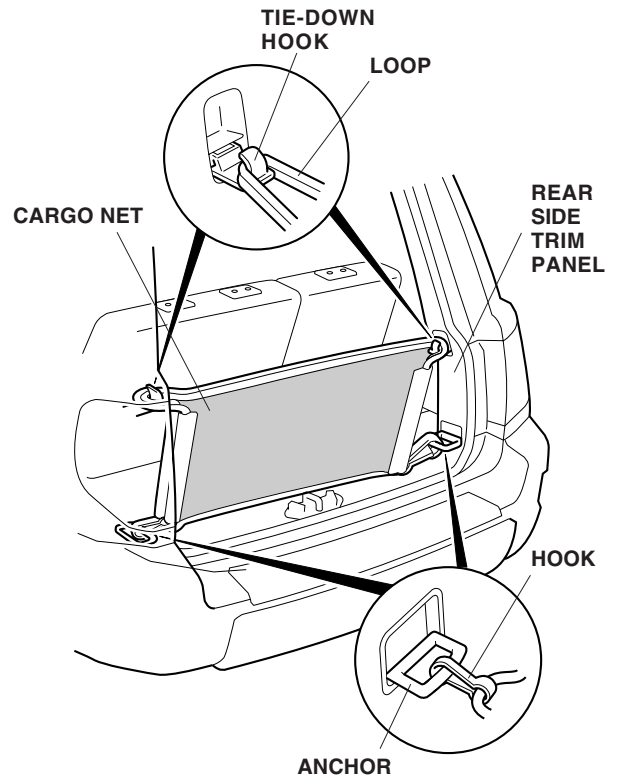

9. Put these instructions and the remaining two hooks (if necessary) in the glove box for your customer.