



INSTALLATION INSTRUCTIONS

Accessory	Application	Publications No.
DOOR EDGE GUARDS	2006 CIVIC HYBRID	All 30319
		Issue Date
		SEP 2005

PARTS LIST

Left front door edge guard



Right front door edge guard



Left rear door edge guard



Right rear door edge guard



Hem sealant cutting tool

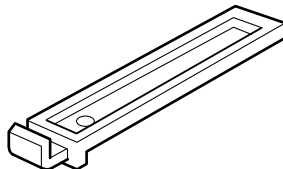

TOOLS REQUIRED

- Rubber mallet
- Felt-tip pen
- Touch-up paint
- Tape measure

INSTALLATION

Customer Information: The information in this installation instruction is intended for use only by skilled technicians who have the proper tools, equipment, and training to correctly and safely add equipment to your vehicle. These procedures should not be attempted by "do-it-yourselfers."

NOTE: These instructions show the right door edge guards being installed. The same procedure applies to installing the left door edge guards.

1. Clean and wax the areas to be covered with a high-quality paste wax.
2. Identify each door edge guard by holding it up to the door and matching its contour with the door edge.

Installing the Front Door Edge Guards

- Using a tape measure and a felt-tip pen, measure and mark the inside edge of the right front door at the measurements shown.

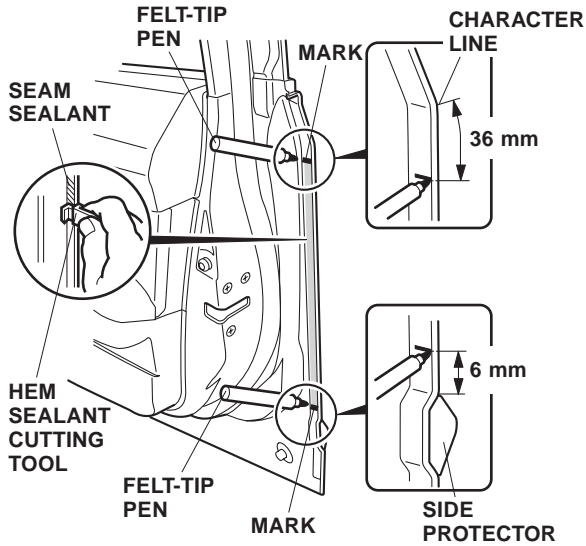

- Position the hem sealant cutting tool against the door edge, and trim the seam sealant from mark to mark.

NOTE: The cutting tool only cuts in one direction. Move it upward on the right door, and downward on the left door.

- Apply touch-up paint to the door, and let it dry.

- Position the right front door edge guard on the door edge, and tap it into position with a series of light taps with a rubber mallet.

NOTE: Be sure to tap the front door edge guard into position with a series of light taps. Once in place, do not remove, reposition, or reinstall the door edge guard, otherwise it will not hold securely.

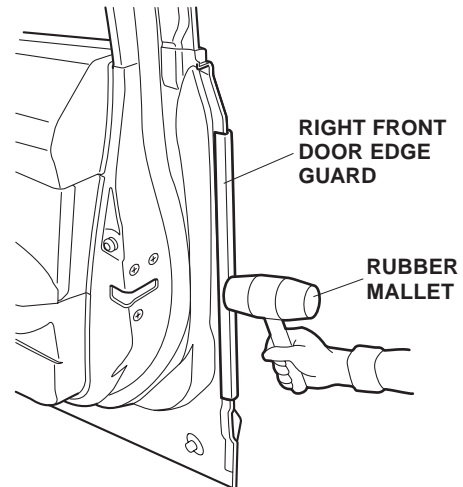
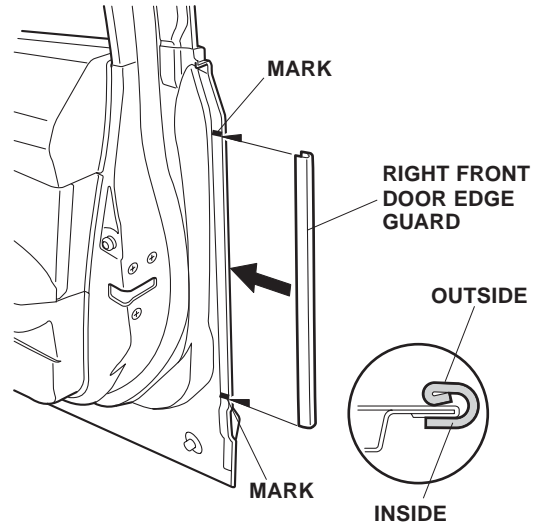

- Repeat steps 3 through 6 to install the left front door edge guard.

Installing the Rear Door Edge Guards

- Using a tape measure and a felt-tip pen, measure and mark the inside edge of the right rear door at the measurements shown.

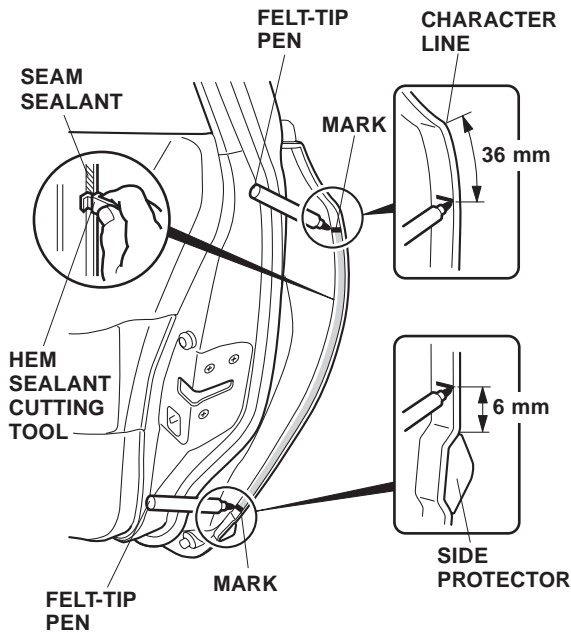

- Position the hem sealant cutting tool against the door edge, and trim the seam sealant from mark to mark.

NOTE: The cutting tool only cuts in one direction. Move it upward on the right door, and downward on the left door.

- Apply touch-up paint to the door, and let it dry.

- Position the right rear door edge guard on the door edge, and tap it into position with a series of light taps with a rubber mallet.

NOTE: Be sure to tap the rear door edge guard into position with a series of light taps. Once in place, do not remove, reposition, or reinstall the door edge guard, otherwise it will not hold securely.

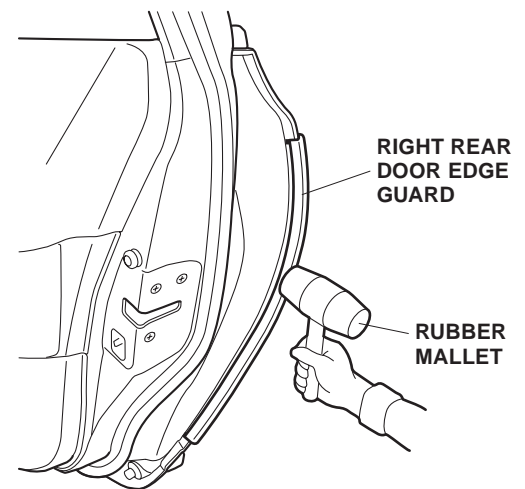
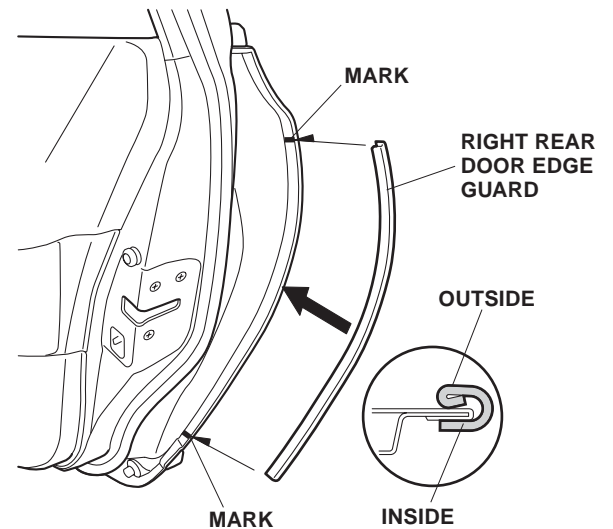

- Repeat steps 8 through 11 to install the left rear door edge guard.